

Article number: 588N3A612CB0471

Description: Solenoid valve type N3A612.CB0.471 3/2 NC
24 VDC orifice 1,2 housing in Brass Inlet port M5

Measures

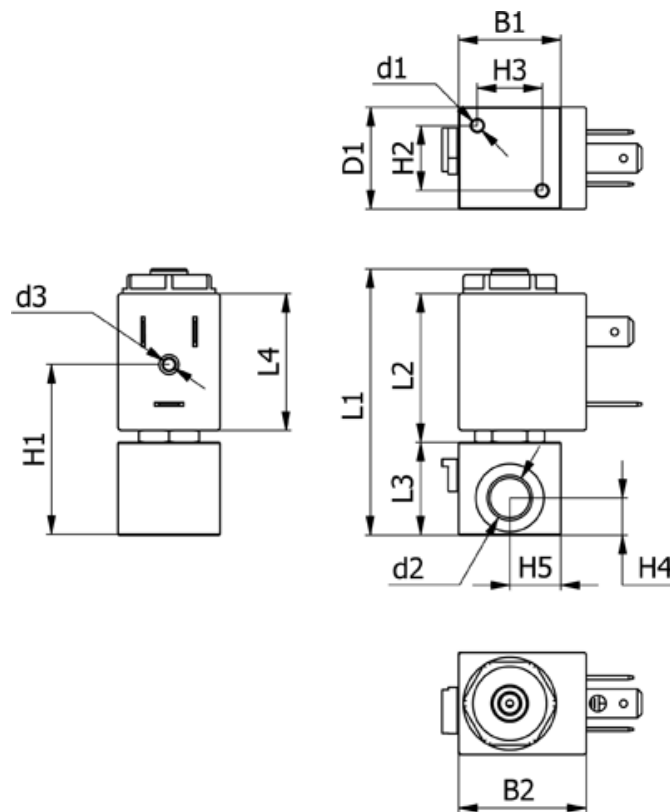

B1 = 22	H2 = 14	Orifice = 1.2
B2 = 31.1	H3 = 14	Valve function = 3/2 NC
d1 = M3x6	H4 = 6	Voltage = 24 VDC
D1 = 22	H5 = 11	
d2 = M5	L1 = 52.2	
d3 = M3x4	L2 = 32.1	
Flow = 0.5	L3 = 16	
H1 = 32.6	L4 = 29.5	